



Musical Instruments

by Beatrice Wilder

Contents

Worksheet 1	Families Draw a line between the instrument and its name and family
Worksheet 2	String Family Becoming familiar with the string family
Worksheet 3	Multiple Choice Quiz Tick the correct family
Worksheet 4	Woodwind Family Becoming familiar with the woodwinds
Worksheet 5	Word Search Instruments and their families
Worksheet 6	Brass Family Becoming familiar with the brass family
Worksheet 7	Crossword All names of orchestral instruments
Worksheet 8	Percussion Family Becoming familiar with the percussion family
Worksheet 9	The Orchestra Colour in sections showing the layout of an orchestra
Worksheet 10	Facts about the Orchestra Finding out a bit more about the orchestra
Worksheet 11	Odd One Out Circle the instrument that does not belong to the same family
Worksheet 12	Aerophones Learning about and identifying aerophones
Worksheet 13	Scrambled Letters Unscramble names of orchestral instruments
Worksheet 14	Reed Instruments Learning about and identifying reed instruments
Worksheet 15	Instrument Details Names and details of four orchestral instruments
Worksheet 16	Membranophones Learning about and identifying instruments with vibrating membranes
Worksheet 17	Quick Quiz Details of instruments
Worksheet 18	Choose an Owner Placing instruments with suitable owners
Worksheet 19	What Instrument Am I? Identify instruments from clues given.
Worksheet 20	Name the Instrument Draw lines to identify instruments
Worksheet 21	Percussion Instruments Information and names of various percussion instruments
Worksheet 22	Word Search Identifying instruments from descriptions given
Worksheet 23	Tick the Correct Answers Multiple choice quiz.
Worksheet 24	List of Musical Instruments

Copyright © Beatrice Wilder 2002
Published in 2002 by **Music Fun**

P.O. Box 342 Katoomba NSW 2780
19 Millyard Lane Katoomba 2780

Phone: (02) 4782 3073

Email: info@musicfun.net.au

Web: www.musicfun.net.au

Please feel free to contact us with any questions about
the copying and use of our worksheets in your school.



Musical Instruments

Worksheet 1

Name

Families

- 1) Draw a line between each instrument and its name.
- 2) Draw a line between each instrument and its orchestral family.

String Family

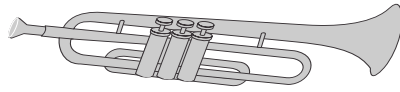

Timpani

Brass Family

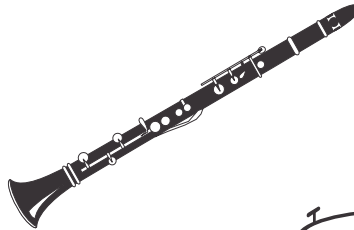

Trumpet

Percussion Family

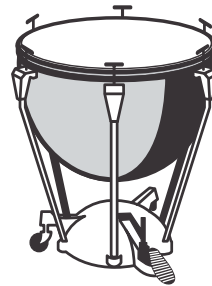

Violin

Woodwind Family



Trombone

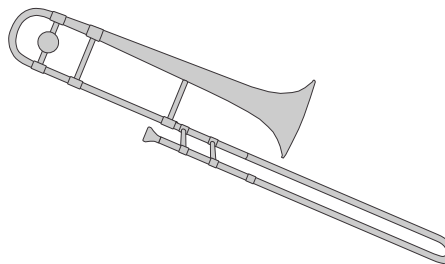

Clarinet

3. Write the name of another instrument in the STRING FAMILY
4. Write the name of another instrument in the BRASS FAMILY
5. Write the name of another instrument in the PERCUSSION FAMILY
6. Write the name of another instrument in the WOODWIND FAMILY
7. To which family does the XYLOPHONE belong?



Musical Instruments

Worksheet 2

Name

String Family

Instruments whose sounds are produced by stretched strings belong to the string family.

Which of the following instruments are not string instruments.

Cross them out.

Viola

Timpani

Harp

Double bass

Electric bass

Harmonica

Shekere

Violin

Cello

Banjo

Piano

Zither

Guitar

Mandolin

Kit

Make your own list of string instruments.

Do some research to see if you can find some which are not on the above list.

.....

.....

.....

.....

.....

.....

.....

.....

.....

.....

.....

.....

Which string instruments would you usually find in a symphony orchestra?

.....

.....



Musical Instruments

Worksheet 3

Name

Multiple Choice (Tick the correct family)

Oboe	<input type="checkbox"/> String <input type="checkbox"/> Brass <input type="checkbox"/> Woodwind <input type="checkbox"/> Percussion	Double bass	<input type="checkbox"/> String <input type="checkbox"/> Brass <input type="checkbox"/> Woodwind <input type="checkbox"/> Percussion	Bass drum	<input type="checkbox"/> String <input type="checkbox"/> Brass <input type="checkbox"/> Woodwind <input type="checkbox"/> Percussion
Cymbals	<input type="checkbox"/> String <input type="checkbox"/> Brass <input type="checkbox"/> Woodwind <input type="checkbox"/> Percussion	Bassoon	<input type="checkbox"/> String <input type="checkbox"/> Brass <input type="checkbox"/> Woodwind <input type="checkbox"/> Percussion	Trumpet	<input type="checkbox"/> String <input type="checkbox"/> Brass <input type="checkbox"/> Woodwind <input type="checkbox"/> Percussion
French horn	<input type="checkbox"/> String <input type="checkbox"/> Brass <input type="checkbox"/> Woodwind <input type="checkbox"/> Percussion	Cello	<input type="checkbox"/> String <input type="checkbox"/> Brass <input type="checkbox"/> Woodwind <input type="checkbox"/> Percussion	Clarinet	<input type="checkbox"/> String <input type="checkbox"/> Brass <input type="checkbox"/> Woodwind <input type="checkbox"/> Percussion
Cor Anglais	<input type="checkbox"/> String <input type="checkbox"/> Brass <input type="checkbox"/> Woodwind <input type="checkbox"/> Percussion	Trombone	<input type="checkbox"/> String <input type="checkbox"/> Brass <input type="checkbox"/> Woodwind <input type="checkbox"/> Percussion	Saxophone	<input type="checkbox"/> String <input type="checkbox"/> Brass <input type="checkbox"/> Woodwind <input type="checkbox"/> Percussion
Viola	<input type="checkbox"/> String <input type="checkbox"/> Brass <input type="checkbox"/> Woodwind <input type="checkbox"/> Percussion	Castanets	<input type="checkbox"/> String <input type="checkbox"/> Brass <input type="checkbox"/> Woodwind <input type="checkbox"/> Percussion	Euphonium	<input type="checkbox"/> String <input type="checkbox"/> Brass <input type="checkbox"/> Woodwind <input type="checkbox"/> Percussion
Tuba	<input type="checkbox"/> String <input type="checkbox"/> Brass <input type="checkbox"/> Woodwind <input type="checkbox"/> Percussion	Violin	<input type="checkbox"/> String <input type="checkbox"/> Brass <input type="checkbox"/> Woodwind <input type="checkbox"/> Percussion	Snare drum	<input type="checkbox"/> String <input type="checkbox"/> Brass <input type="checkbox"/> Woodwind <input type="checkbox"/> Percussion
Xylophone	<input type="checkbox"/> String <input type="checkbox"/> Brass <input type="checkbox"/> Woodwind <input type="checkbox"/> Percussion	Flute	<input type="checkbox"/> String <input type="checkbox"/> Brass <input type="checkbox"/> Woodwind <input type="checkbox"/> Percussion	Gong	<input type="checkbox"/> String <input type="checkbox"/> Brass <input type="checkbox"/> Woodwind <input type="checkbox"/> Percussion



Musical Instruments

Worksheet 4

Name

Woodwind Family

Instruments which are blown into (wind) and which were often originally made of wood. Woodwinds can then be divided into two sub-families: flutes, where air is blown across a mouthpiece and reed instruments where air causes the reeds in a mouthpiece to vibrate..

Which of the following instruments are not woodwind instruments.
Cross them out.

Recorder

Flute

Oboe

Guero

Bassoon

Sansa

Cor anglais

Bagpipes

Piccolo

Saxophone

Lute

Harmonica

Krummhorn

Jew's harp

Clarinet

Make your own list of woodwind instruments.

Do some research to see if you can find some which are not on the above list.

.....
.....
.....
.....
.....
.....

Which woodwinds would you usually find in a symphony orchestra?

.....

.....



Musical Instruments

Worksheet 5

Name

Word Search

Find musical instruments reading across or down
and draw circles around them.

In the list below tick the box next to each name as you find it
then write the family to which it belongs.

n	o	o	s	s	a	b	r	o	v	a	s
r	l	x	s	u	a	l	o	i	v	s	a
o	l	o	c	c	i	p	o	i	a	l	x
h	e	k	e	t	u	l	f	b	c	a	o
h	c	l	a	r	i	n	e	t	a	b	p
c	o	r	a	n	g	l	a	i	s	m	h
n	t	r	o	m	b	o	n	e	t	y	o
e	g	t	r	u	m	p	e	t	a	c	n
r	o	x	o	t	i	m	p	a	n	i	e
f	n	d	n	t	u	d	t	b	e	w	o
k	g	x	x	r	o	t	v	u	t	k	b
v	z	l	d	p	z	x	r	t	o	v	o

- | | |
|--------------------------------------|-------|
| <input type="checkbox"/> flute | _____ |
| <input type="checkbox"/> trumpet | _____ |
| <input type="checkbox"/> drum | _____ |
| <input type="checkbox"/> viola | _____ |
| <input type="checkbox"/> trombone | _____ |
| <input type="checkbox"/> french horn | _____ |
| <input type="checkbox"/> cymbal | _____ |
| <input type="checkbox"/> clarinet | _____ |
| <input type="checkbox"/> piccolo | _____ |
| <input type="checkbox"/> cello | _____ |

- | | |
|--------------------------------------|-------|
| <input type="checkbox"/> tuba | _____ |
| <input type="checkbox"/> castanet | _____ |
| <input type="checkbox"/> saxophone | _____ |
| <input type="checkbox"/> oboe | _____ |
| <input type="checkbox"/> violin | _____ |
| <input type="checkbox"/> timpani | _____ |
| <input type="checkbox"/> cor anglais | _____ |
| <input type="checkbox"/> bassoon | _____ |
| <input type="checkbox"/> double bass | _____ |
| <input type="checkbox"/> gong | _____ |



Musical Instruments

Worksheet 6

Name

Brass Family

Brass instruments are usually made of brass but are sometimes made of other metals. Some instruments are made of brass or other metals but belong to the woodwind family.

Which of the following instruments do not belong to the family of brass instruments. Cross them out.

French horn

Trumpet

Cornet

Saxophone

Metallophone

Tuba

English horn

Trombone

Euphonium

Bugle

Guitar

Sousaphone

Oboe

Hunting horn

Cymbals

Make your own list of brass instruments.

Do some research to see if you can find some which are not on the above list.

.....
.....
.....
.....
.....
.....

Which brass instruments would you usually find in a symphony orchestra?

.....

.....



Crossword

The answers to the clues in this crossword puzzle are all names of musical instruments.

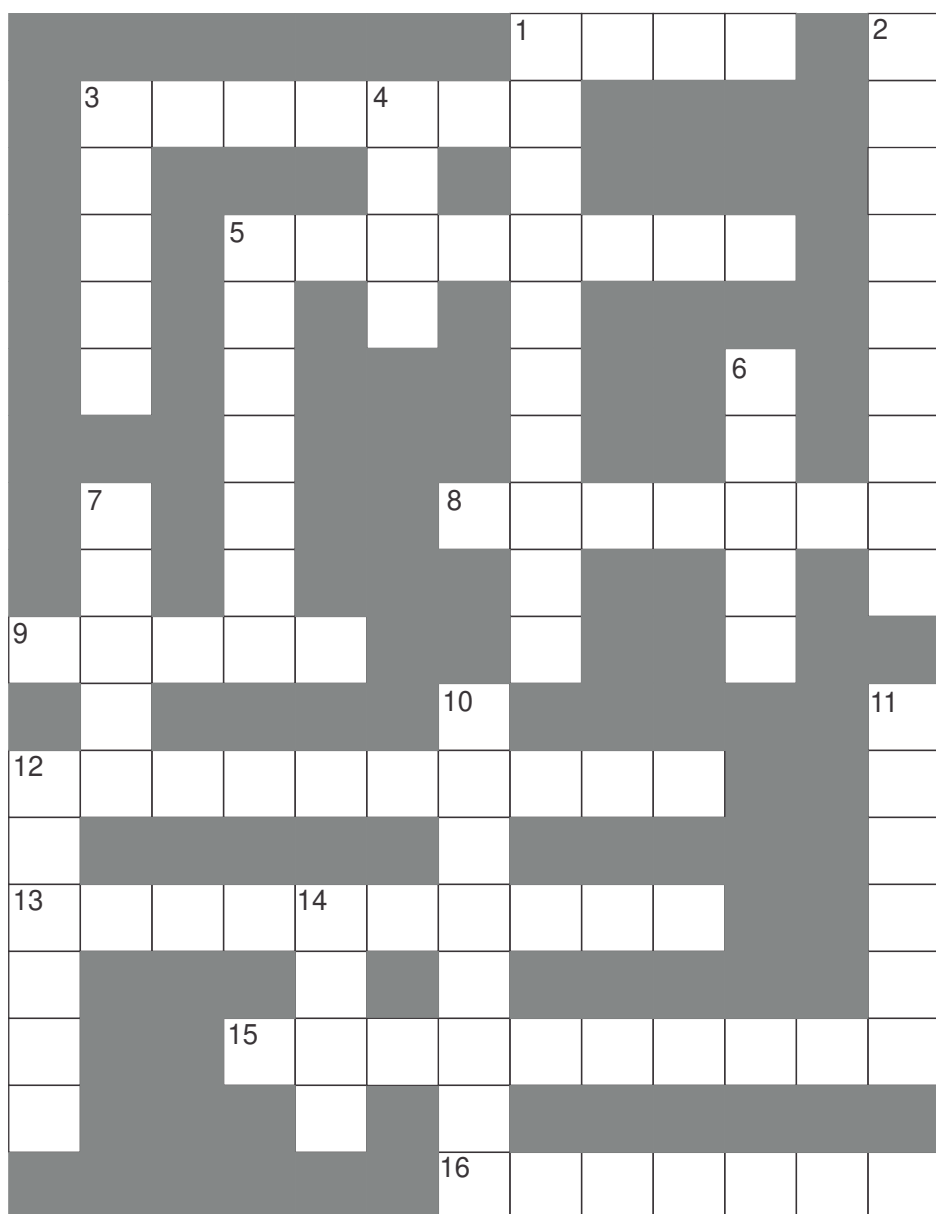

ACROSS

1. Percussion with stretched skin.
3. High pitched woodwind.
5. Brass instrument without valves.
8. Low pitched double reed woodwind.
9. Woodwind without reed, usually made of metal.
12. Mid-range double reed woodwind.
13. Common name for harmonica.
15. Brass instrument with valves, its tubing in circular coils.
16. Large deep percussion with stretched skin.

DOWN

1. Largest in the string family.
2. Single reed instrument made of brass.
3. Keyboard instrument.
4. Double reed woodwind instrument.
5. Brass instrument with valves.
6. Stringed instrument.
7. Stringed instrument which rests on the floor whilst being played.
10. Single reed woodwind.
11. Highest pitched in the string family.
12. Percussion instrument clashed together in pairs.
14. Instrument with many strings which is not played with a bow.



Musical Instruments

Worksheet 8

Name

Percussion Family

Instruments which need to be hit or shaken to make a sound are called percussion instruments.

Which of the following instruments are not percussion instruments.
Cross them out.

Woodblocks

Marimba

Triangle

Guiro

Bassoon

Bells

Tambourine

Gong

Xylophone

Castanets

Timpani

Piano

Tuba

Bongo drums

Whip

Make your own list of percussion instruments.

Do some research to see if you can find some which are not on the above list.

.....
.....
.....
.....
.....
.....

Which percussion instruments would you usually find in a symphony orchestra?

.....

.....



The Orchestra

This is the typical layout of a symphony orchestra.

Fill in the blocks of instruments according to the family to which each belongs.

Use a different colour for each family as follows...

Blue for **Percussion**

Yellow for **Brass**

Green for **Woodwind**

Red for **Strings**

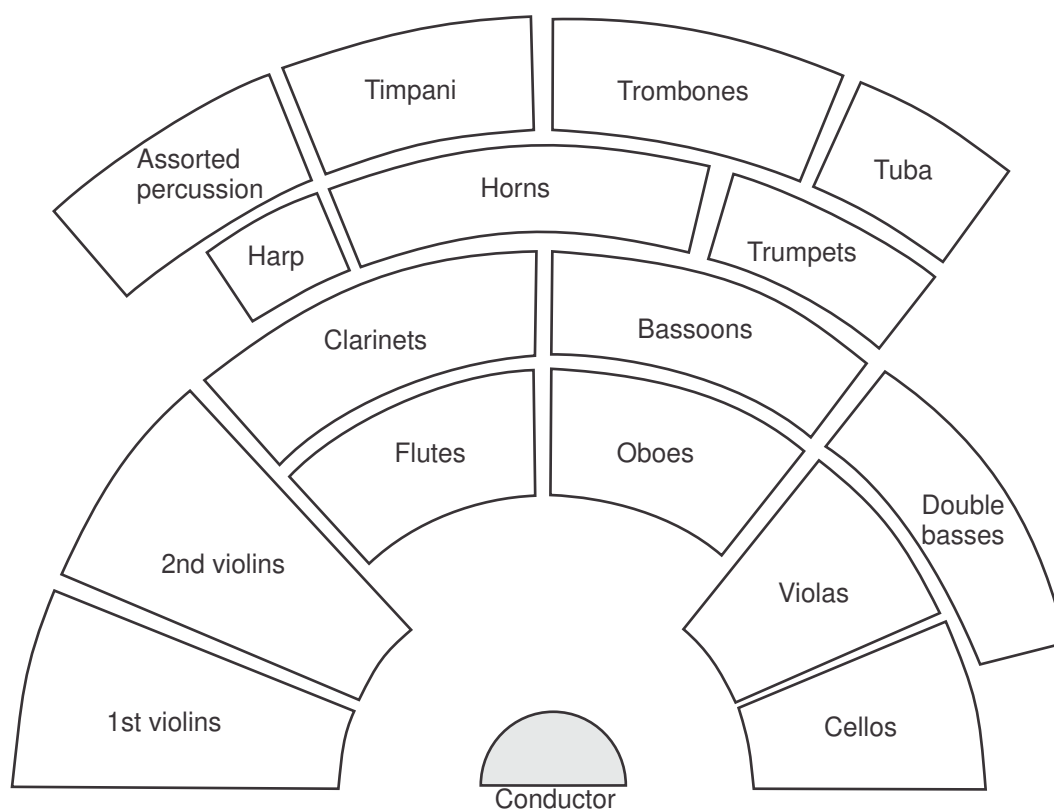

Instruments of the orchestra



Musical Instruments

Worksheet 10

Name

Facts about the Orchestra

Use the terms in the column on the right to complete the details.
Cross out the answers as you use them. Use each answer only once.
You may need to use your dictionary.

1. The art of arranging music for an orchestra is called

.....

2. An instrumental ensemble - or a number of instruments playing together - is called a

.....

3. A small orchestra is called a

.....

4. The person controlling the musical performance of the orchestra is called the

.....

5. The collection, or ensemble, of instruments chosen to play a particular composition is called the

.....

6. Voices played together, providing melodies, rhythms and musical texture supporting each other is called

.....

Research: Find the names of six famous orchestras.

.....

.....

.....

- Chamber Orchestra
- Instrumentation
- Orchestration
- Conductor
- Symphony
- Polyphony



Musical Instruments

Worksheet 11

Name

Odd One Out

Circle the instrument name which does not belong to the same family as the others

1)	<i>Trumpet</i>	<i>French horn</i>	<i>Piccolo</i>	<i>Tuba</i>
2)	<i>Timpani</i>	<i>Cello</i>	<i>Double bass</i>	<i>Viola</i>
3)	<i>Oboe</i>	<i>Castanets</i>	<i>Bassoon</i>	<i>Flute</i>
4)	<i>Snare drum</i>	<i>Cymbals</i>	<i>Xylophone</i>	<i>Cor anglais</i>
5)	<i>Trombone</i>	<i>Triangle</i>	<i>Tuba</i>	<i>French horn</i>
6)	<i>Saxophone</i>	<i>Harp</i>	<i>Violin</i>	<i>Double bass</i>
7)	<i>Bassoon</i>	<i>Clarinet</i>	<i>Timpani</i>	<i>Oboe</i>
8)	<i>Bass drum</i>	<i>Bass clarinet</i>	<i>Gong</i>	<i>Claves</i>
9)	<i>Tuba</i>	<i>Euphonium</i>	<i>Tenor horn</i>	<i>Cello</i>
10)	<i>Guitar</i>	<i>Accordion</i>	<i>Mandolin</i>	<i>Viola</i>



Musical Instruments

Worksheet 12

Name

AEROPHONES

Any instrument, if the sound is produced by means of moving air, is an aerophone. There are lots of different kinds of aerophones including all wind instruments. However, the term aerophone is not limited to wind instruments. A whip produces sound by means of moving air. It is an aerophone but not a wind instrument. A siren is also an aerophone but not a wind instrument.

Here is a collection of aerophones. We have scrambled the letters. See if you can unscramble them and identify the instruments. The instruments used are included in those listed on the bottom of this page.

- | | | | |
|-------------|-------|-----------|-------|
| Groan | | Rorredec | |
| Lufte | | Moonbert | |
| Swithel | | Pagebips | |
| Mirohuman | | Rinse | |
| Phiw | | Bulge | |
| Corondiac | | Pup-nog | |
| Baru-roller | | Tronce | |
| Shupoonaes | | Aircoan | |
| Maranochi | | Pippena | |
| Trincale | | Sosonba | |
| Poxashone | | Murpett | |
| Morchurn | | Chromfhen | |

- | | | | | | | | |
|---------|-------|----------|------------|-------------|----------|-------------|-----------|
| Ocarina | Tuba | Clarinet | Recorder | Alpine horn | Bagpipes | Pop-gun | Saxophone |
| Rackett | Siren | Bassoon | Panpipe | Bull-roarer | Organ | Crumhorn | Serpent |
| Whistle | Whip | Trombone | Ophicleide | Harmonium | Flute | French horn | Posthorn |
| Cornet | Bugle | Piccolo | Sousaphone | Harmonica | Trumpet | Shawm | Accordion |



Musical Instruments

Worksheet 13

Name

Scrambled Letters

Unscramble the letters of these
musical instruments

<i>PUTREMT</i> -----	<i>NARGTILE</i> -----
<i>RENTLIGA</i> -----	<i>MORTONEB</i> -----
<i>SABONOS</i> -----	<i>RERUMSAND</i> -----
<i>LIVION</i> -----	<i>LOCEL</i> -----
<i>EBOO</i> -----	<i>SLEDABUBOS</i> -----
<i>POLYHOXEN</i> -----	<i>MASCPLY</i> -----
<i>LONGARCISA</i> -----	<i>BAUT</i> -----
<i>ULEFT</i> -----	<i>MAPINIT</i> -----
<i>ROHNNFERCH</i> -----	<i>PHAR</i> -----
<i>LAIVO</i> -----	<i>FRONTIOPAE</i> -----



Musical Instruments

Worksheet 14

Name

Reed Instruments

Many wind instruments depend on a thin, flexible sheet called a reed to produce a musical sound. Reeds used to be always made of cane. These days they can also be made of other materials such as plastic, metal and wood.

Instruments can single-reed, double-reed or free-reed.

Air flow causes the reed to vibrate. The reed in a single-reed instrument vibrates against another surface. The reeds in a double-reed instrument vibrate against each other. A free reed vibrates within its own space.

Use your library to determine whether the following instruments are reed instruments and whether they are single-reed, double-reed or free-reed instruments.

	yes / no	single / double / free reed
Bagpipes
Bassoon
Cor anglais
Piccolo
Crumhorn
Oboe
Saxophone
Clarinet
Harmonica
Flute
Accordion
Shawm

Which reed instruments would you usually expect to find in a symphony orchestra?

.....

.....

.....



Instrument Details

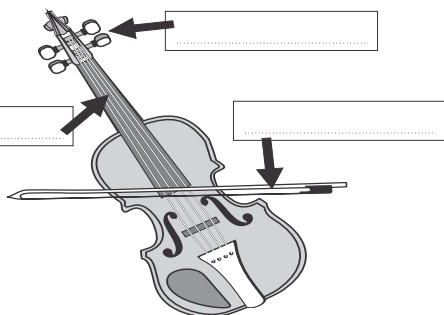

- 1) Name this instrument.

- 2) To which orchestral family does it belong?

- 3) How is a musical sound produced on it?

- 4) Label some of its parts (as indicated).

- 1) Name this instrument.

- 2) To which orchestral family does it belong?

- 3) How is a musical sound produced on it?

- 4) Label some of its parts (as indicated).

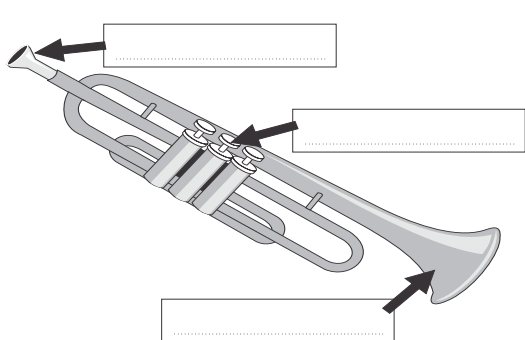
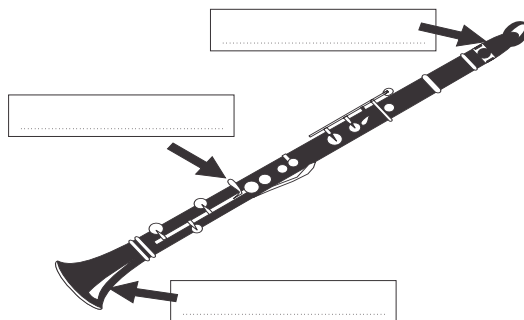

- 1) Name this instrument.

- 2) To which orchestral family does it belong?

- 3) How is a musical sound produced on it?

- 4) Label some of its parts (as indicated).

- 1) Name this instrument.

- 2) To which orchestral family does it belong?

- 3) How is a musical sound produced on it?

- 4) Label some of its parts (as indicated).

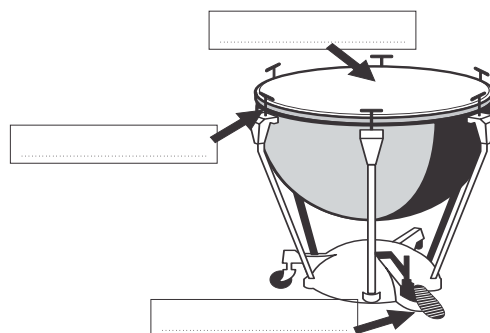



Musical Instruments

Worksheet 16

Name

Membranophones

Any instrument, if the sound is produced by means of a vibrating membrane, or skin, is a membranophone.

Most drums are membranophones - and there are lots of different types of drums.

We have listed some of the properties of various types of membranophones.

See if you can label them correctly from the following group of instruments:

Friction drum	Timpani	Bass drum	Conga drum	Tambourine
Kazoo	Bongo drums	Tambour	Kettle drum	Snare drum

.....
The membrane of this drum is rubbed with wet fingers or a stick.
The Dutch Rommelpot is one of these.

.....
Also called a Side Drum
Has strings of metal stretched across the lower head.
Produces a 'rattling' sound.

.....
Held in one hand, played with the other.
Shallow drum of a small size
Has loose pairs of metal disks at the side.

.....
Known by two of the above names.
Can be tuned and is used in the orchestra.
Usually played in pairs or sets of two to four.

.....
They come from Cuba.
Are played in pairs.
The players use their hands and fingers to play.

.....
An open tube with a hole covered by a membrane.
Changes the sound of a person's voice.
Not a drum.



Musical Instruments

Worksheet 17

Name

Quick Quiz

Name three instruments in the string family

Name three instruments in the woodwind family

Name three instruments in the brass family

Name three instruments in the percussion family

How is a musical sound made on a flute?

How is a musical sound made on a tuba?

How is the pitch changed on a clarinet?

How is a musical sound made on a trombone?

How is the pitch changed on a trombone?

Name two ways by which musical sounds can be made on a violin

Name two ways by which the pitch is changed on a trumpet

Which is lower in pitch, the viola or the cello?

Name one part that the timpani and the snare drum have in common

Name one family of instruments usually found at the back of the orchestra

Name the highest pitched woodwind instrument

To which family does the cor anglais belong?

Name a woodwind instrument that is made of metal

Name one family of instruments usually found at the front of the orchestra

Name the lowest pitched brass instrument



Musical Instruments

Worksheet 18

Name

Choose an Owner

Where would these instruments be used? Who would use them?

Draw lines to match up the musical instrument to its appropriate user.

There could be several correct answers, but each instrument must match up to an owner.

Rock n Roll group

Shaker

Dixieland Jazz Band

Castanets

African musician

Pan pipes

Latin-American group

Koto

Spanish musician

Banjo

Japanese music

Electric guitar

Church choir

Synthesizer

Space movie music

Washboard

Opera singer

Organ

Skiffle Band

Fiddle

Symphony orchestra

Soprano voice

Irish band

Saxophone

Country music

Lute

Dance band

Cello

Turkish players

Harmonica



Musical Instruments

Worksheet 19

Name

What Instrument Am I?

I belong to the string family.
I am held between the knees.
My lowest tone is one octave lower than the viola's lowest tone.

I am a woodwind instrument.
I am held crosswise.
My sound is produced by blowing against the edge of a hole near one end of me.

I belong to the brass family.
I have a mouthpiece and bell but no valves.
I am twice as long as a trumpet and can slide from tone to tone.

I am a woodwind instrument.
I play bright, lively melodies.
I look like a flute but am only half the size and I sound an octave higher.

We belong to the percussion family.
We can be tuned and produce musical tones.
We are always referred to in the plural; there are always at least two of us used.

I am a double-reed woodwind instrument.
I have the highest voice of the reed instruments.
I can be made from wood, plastic or metal and have three main sections apart from my reed.

I am a percussion and a stringed instrument.
I have a range of more than seven octaves.
My sound is made by small hammers hitting my strings.

I am a brass instrument.
I have a mouthpiece, valves, crooks and a bell.
I have the highest voice of all the instruments in the brass family.

I am a bass, pitched brass instrument.
I do not have a slide.
I have the longest tube, deepest voice and widest bell of all the brass instruments.

I am a double-reed woodwind instrument.
My reed is joined to me by a long metal tube.
I usually play the bass parts in my family, but can also play beautiful melodies.



Musical Instruments

Worksheet 20

Name

Name the Instrument

Draw lines joining the instruments to their names.

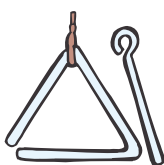
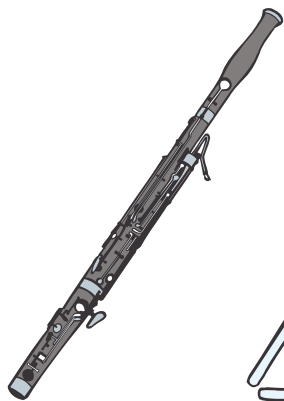

Metallophone

Triangle

Harmonica

Oboe

Vibraphone



Tambourine

Bassoon

French horn

Bugle

Flute

Banjo

Panpipes

Ukulele

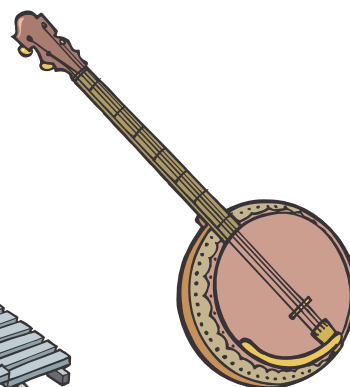
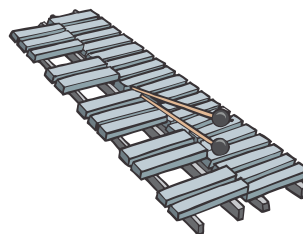
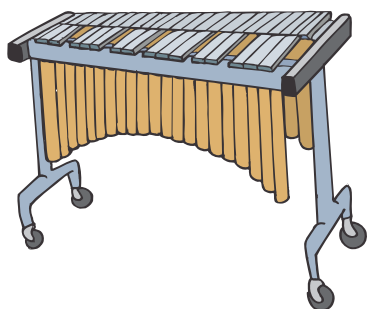
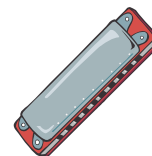
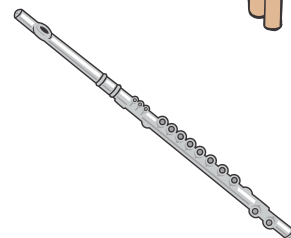
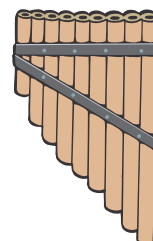
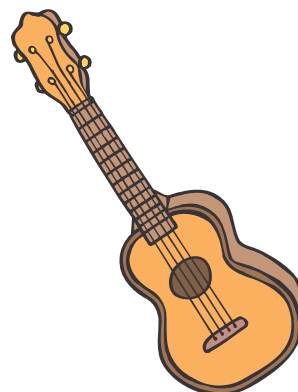



Musical Instruments

Worksheet 21

Name

Percussion Instruments

Percussion instruments are instruments which make a sound when they are hit or shaken. They can be divided into two categories. Those that can be tuned are said to have **definite pitch** and those that cannot be tuned have **indefinite pitch**.

See if you can place these instruments into their proper categories.

- | | | | |
|-----------|---------------|------------|--------------|
| xylophone | cowbells | triangle | guiro |
| bass drum | tubular bells | vibraphone | whip |
| timpani | castanets | marimba | metallophone |
| maracas | claves | tambourine | glockenspiel |
| cymbals | wood block | gong | snare drum |

Tuned Percussion

.....

.....

.....

.....

.....

Untuned Percussion

.....

.....

.....

.....

.....



Musical Instruments

Worksheet 22

Name

WORDSEARCH

This is a little tricky!

Hidden in this word search are the names of instruments fitting the descriptions given below.

N	R	O	H	H	C	N	E	R	F	G	B	F
I	A	V	I	O	L	I	N	X	D	R	A	L
N	O	O	S	S	A	B	I	B	Q	C	G	U
A	L	B	L	B	A	B	R	W	I	E	P	T
P	O	X	A	E	F	X	U	N	L	N	I	E
M	C	Z	B	L	B	U	O	T	Q	O	P	E
I	C	D	M	G	A	M	B	P	O	B	E	A
T	I	W	Y	N	R	L	M	N	H	M	S	O
G	P	O	C	A	G	A	A	W	L	O	X	L
V	C	M	H	I	E	I	T	I	R	R	N	L
S	C	H	A	R	P	Q	F	I	K	T	F	E
Y	G	U	I	T	A	R	T	V	S	A	T	C

6 strings, long slender neck _____

Deeper voice than a viola _____

Played with a bow, has 4 strings _____

Russian lute _____

Geometric shape, percussion _____

Very deep sounding horn _____

Double reed, deep voice _____

Also called a mouth organ _____

Single reed, used in jazz _____

String instrument, plucked _____

Has black keys and white keys _____

Small flute _____

Woodwind, often made of silver _____

Hindu lute _____

Has valves and lots of tubing _____

Brass instrument with slide _____

Also called kettle drums _____

Scottish aerophones _____

Metal concussion instruments _____

Small drum with metal discs _____



Musical Instruments

Worksheet 23

Name

Tick the correct answers

Piccolo is really: a type of recorder
 a half size flute
 used to play a guitar

Cor anglais is: the English horn
 the conductor's baton
 a string instrument

Violins have: six strings
 three strings
 four strings

A flute is a: woodwind instrument
 brass instrument
 type of drumstick

The oboe is: used for playing drums
 a double-reed instrument
 part of a trombone

The French horn: is a large English horn
 is a low voice woodwind
 is brass and has valves

The cello is: held under the chin
 made of brass
 held between the knees

A bass drum is: untuned percussion
 tuned percussion
 not percussion

The viola is: held under the chin
 played standing up
 held between the knees

A tuba has: valves, bell, crooks
 slide, bell, mouthpiece
 reed, bell, keys

Timpani are: the smallest woodwinds
 little bells
 percussion instruments

The trombone is: a percussion instrument
 a brass instrument
 usually made of wood

A xylophone is a: tuned percussion
 untuned percussion
 keyboard instrument

A trumpet has a: higher voice than a tuba
 lower voice than a tuba
 keyboard instrument

A bassoon is a: low sounding violin
 double-reed woodwind
 type of cymbal

The clarinet has: a mouthpiece, bell, keys
 slide, bell, crooks
 valves, pistons, bell

Cymbals are: made of silver
 made of brass
 made of steel

Snare drums are: small timpani
 part of a xylophone
 metallic sounding drums



Musical Instruments

Worksheet 24

LIST

Wind Instruments

Note:

Woodwind instruments are not always made of wood. The term covers instruments which belong to the families of the bassoon, clarinet, flute and oboe. The flute, which is not made of wood, is termed a woodwind. The saxophone, when it is used in the orchestra, is also called a woodwind.

Bass clarinet
Bagpipes
Baritone
Bassoon
Bugle
Clarinet
Contrabassoon
Cor anglais (English horn)
Cornet
Crumhorn
Didgeridoo
Euphonium
Flageolet
Fl \downarrow gel horn
Flute
French horn
Harmonica
Hornpipe
Oboe
Ocarina
Ophicleide
Panpipes
Piccolo
Rackett
Recorder
Reedpipe
Sarusophone
Saxophone
Serpent
Soprano saxophone
Sousaphone
Shawm
Tarogato
Trombone
Trumpet
Tuba
Whistle

Stringed Instruments

Balalaika
Banjo
Cello
Chitarrone
Cittern
Double bass
Dulcimer
Electric guitar
Guitar
Harp
Hawaiian Guitar
Hurdy-gurdy
Kit
Lute
Lyre
Mandolin
Sitar
Theorbo
Ukulele
Vina
Violin
Viola
Zither

Keyboard Instruments

Piano
Harpsichord
Celesta
Clavichord
Pipe Organ
Theatre organ
Synthesizer

Other Instruments

Accordion
Bull roarer
Cimbalon
Concertina
Dulcimer
Jews Harp
Rommelpot
Sansa
Zambomba

Percussion Instruments (also Concussion Instr)

Anvil
Bamboo chimes
Bass drum
Bell chimes
Bongo drums
Castanets
Chains
Chimes
Claves
Conga drum
Cowbells
Cymbals
Glass chimes
Glockenspiel
Gong
Guiro
Hand bells
High hat
Maracas
Marimba
Metallophone
Rattle
Shekere
Sleigh bells
Slit drum
Snare drum
Steel drum
Tambour
Tambourine
Temple blocks
Timbales
Timpani
Tom tom
Triangle
Tubular bells
Vibraphone
Washboard
Whip
Woodblock
Xylophone